

RADIANT GRILLS

850-Radiant Grill / Lava Rock

Features

- 1. Top section** - Manufactured from 1.6mm 430 st/steel.
- 2. Splash guards** - 2mm st/steel splash guards.
- 3. Body** - Front and sides are constructed from 0.9mm grade 430 st/steel.
- 4. Burners** - Burners are controlled with CE 0025AQ0608 rated gas valves and have an adjustable minimum low level setting.
Burners easily removed for cleaning purposes.



Drawings

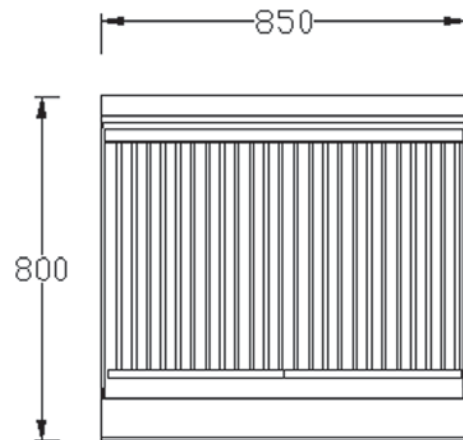
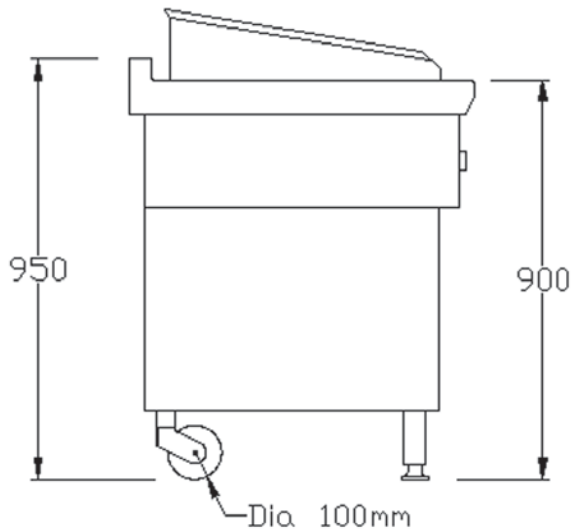

Specifications

Dimensions:	850(W) x 800(D) x 950(H)
No. of burners:	6 burners
Gas rating:	95 000 kj/Hr
Gas pressure:	LPG 2.7 Kpa TG 6.735 Kpa
Gas connection:	20mm BSP

Optional Extras

Body can be manufactured from:	304 st/steel
Front door to suite	
Cast iron grids or 10mm mild steel grids	
St/steel radiant reflective baffles or Lava Rock	